

COSC451: Artificial Intelligence

Lecture 12: Introduction to Minimalist syntax II

Alistair Knott

Dept. of Computer Science, University of Otago

Recap

My example sentence: **The man grabbed a cup.**

Recap

My example sentence: **The man grabbed a cup.**

The proposal I'm making:

Recap

My example sentence: **The man grabbed a cup.**

The proposal I'm making:

- 1 The sensorimotor processes involved in 'experiencing' the action of grabbing a cup have the form of a sequence.

Recap

My example sentence: **The man grabbed a cup.**

The proposal I'm making:

- 1 The sensorimotor processes involved in 'experiencing' the action of grabbing a cup have the form of a sequence.
- 2 This sequence is initially retained in working memory as a **sequence plan**, which can later be **replayed** to long-term memory.

Recap

My example sentence: **The man grabbed a cup.**

The proposal I'm making:

- 1 The sensorimotor processes involved in 'experiencing' the action of grabbing a cup have the form of a sequence.
- 2 This sequence is initially retained in working memory as a **sequence plan**, which can later be **replayed** to long-term memory.
- 3 The 'deep' syntactic structure of the sentence can be read as a description of the process of replaying the working memory sequence to long-term memory.

Replay of the WM sequence: timecourse of signals

Sustained signals	Transient signals		
	Context signals	Action signals	Reafferent signals
$plan_{attend_agent/attend_cup/grasp}$ ↓ ↓	C_1	$attend_agent$	$attending_agent$
$plan_{attend_agent/attend_cup/grasp}$ ↓ ↓	C_2	$attend_cup$	$attending_cup$
$plan_{attend_agent/attend_cup/grasp}$ ↓ ↓	C_3	$grasp$	$attending_agent$
$plan_{attend_agent/attend_cup/grasp}$ ↓ ↓	C_4		$attending_cup$

Outline of today's lecture

- 1 What do linguists do?
- 2 Introduction to GB/Minimalism
- 3 Components of the Minimalist model
- 4 Minimalist analysis of a transitive clause

Outline of today's lecture

- 1 What do linguists do?
- 2 Introduction to GB/Minimalism
- 3 Components of the Minimalist model
- 4 Minimalist analysis of a transitive clause

What's the objective of a syntactic theory?

What's the objective of a syntactic theory?

Objective (version 1): to *describe a human language* (call it L).

What's the objective of a syntactic theory?

Objective (version 1): to *describe a human language* (call it L).

There are infinitely many sentences in any human language.

What's the objective of a syntactic theory?

Objective (version 1): to *describe a human language* (call it L).

There are infinitely many sentences in any human language.

- So to describe L , we need to define a mechanism which *generates* all (and only) the sentences in L .
(The generative mechanism is a way of stating a declarative theory—not a model of how people produce sentences.)

What's the objective of a syntactic theory?

Objective (version 1): to *describe a human language* (call it L).

There are infinitely many sentences in any human language.

- So to describe L , we need to define a mechanism which *generates* all (and only) the sentences in L .
(The generative mechanism is a way of stating a declarative theory—not a model of how people produce sentences.)

The mechanism is a collection of *rules*, which define what counts as a 'well-formed sentence' in L .

- These rules operate *recursively*: they explain how words combine into **phrases**, and how phrases combine into sentences.

What's a syntactic analysis?

Take a sentence S in a particular language.

(E.g. **The man grabbed a cup.**)

- Once we have our generative mechanism, we can *describe* how this mechanism generates S .

This description can be given as a specification of the hierarchical **phrase structure** of S .

- The terminal nodes in the structure are words.
- Each nonterminal node describes the application of a phrase-formation rule.

An example

Here's a simple generative mechanism:

$S \rightarrow NP, VP$
 $NP \rightarrow Det, N$
 $VP \rightarrow VT, NP$
 $Det \rightarrow the$
 $Det \rightarrow a$
 $N \rightarrow man$
 $N \rightarrow cup$
 $VT \rightarrow grabbed$

Here's a description of how it generates *the man grabbed a cup*.

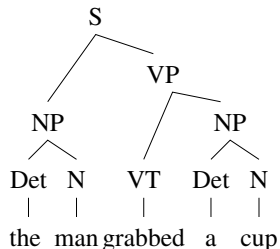

What's the objective of a syntactic theory?

Objective (version 2): to describe the **human language faculty**.

A *human speaker* of language L must have a generative mechanism for L 'on board'.

- Assumption: most of this generative mechanism is *innately given*. (This is the Chomskyan **Universal Grammar (UG)** hypothesis.)
- Children 'parameterise' their generative mechanism when they learn their mother tongue.

A linguist with this goal must build a generative mechanism which can be parameterised for any human language.

What's the objective of a syntactic theory?

Objective (version 3): to explain how sentences get their **meanings**.

Assumption: we use a sentence's phrase structure to derive its meaning.

- Each word in the sentence has a stored meaning.
- The meaning of each *phrase* in the sentence is *constructed* from the meaning of its component elements.

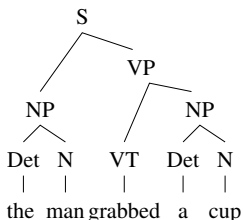

Outline of today's lecture

- 1 What do linguists do?
- 2 Introduction to GB/Minimalism**
- 3 Components of the Minimalist model
- 4 Minimalist analysis of a transitive clause

Choosing a syntactic framework

I'm using Chomsky's **generative grammar** tradition as my syntactic framework.

- Theorists working in this tradition are trying to develop a parameterisable UG model, rather than just a description of individual languages. (C.f. Objective 2)
- They also want their model to explain how sentences get their meaning. (C.f. Objective 3)

GB and Minimalism

Generative grammar has undergone many changes over fifty years.

- I'm drawing mainly on the **Minimalist model** (Chomsky, 1995).
- But for exposition I'll also refer to the **Government-and-Binding (GB)** model of the 1980s.

Phonetic form and logical form

In Minimalism, a sentence needs to be described at two different syntactic levels.

- **Phonetic form (PF)** represents the surface form of the sentence.
- **Logical form (LF)** is ‘the level of syntactic representation which interfaces with the semantic system’.

I’ll assume that all translations of *The man grabbed a cup* have the same LF.

Outline of today's lecture

- 1 What do linguists do?
- 2 Introduction to GB/Minimalism
- 3 Components of the Minimalist model**
- 4 Minimalist analysis of a transitive clause

Components of the Minimalist model

The Minimalist model has two components:

- A definition of what **phrases** are
- A generative mechanism for forming (and altering) phrases.

(Most of the complexity of the model is in the generative mechanism.)

Definition of phrases

The basic unit of phrase structure is the **X-bar schema**.

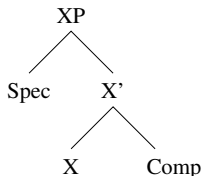

Each word in a sentence contributes an XP structure.

- The **head** of the structure (X) is the word itself.
- The structure also has slots for a **specifier** (Spec) and a **complement** (Comp).
- These slots can (recursively) be occupied by other XPs.

Motivating the X-bar schema

What evidence is there that the X-bar schema is the basic building block?

A simple idea:

- Each word in a sentence contributes its own piece of syntactic structure, creating positions for its **arguments**.
- There seem to be generalisations between the structures contributed by different word categories.

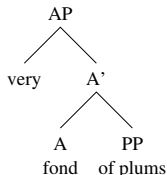
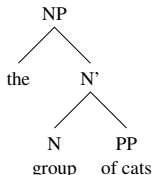
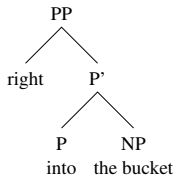
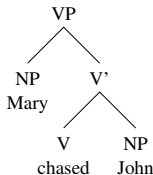

But why the *asymmetry* between Spec and Comp?

Why not make the schema look like this?

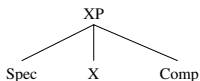

- For VP, we can motivate the asymmetry using the *do so* argument.

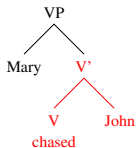

- For all XPs, we need an intermediary projection for recursion.

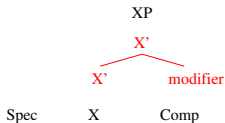

But what about words with *more than two arguments*?

How should we analyse

John put the cup into the sink

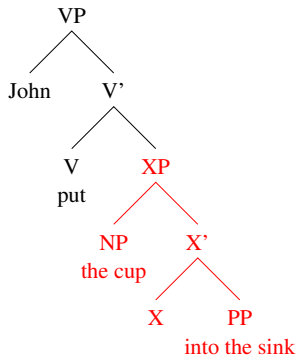
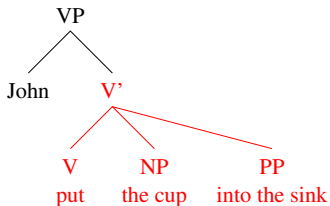

The generative mechanism

The generative mechanism builds a **phrase structure** (out of XPs), and then alters it.

- It begins with a series of **phrase formation operations**, in which XPs are created and joined together.
- Then there's a series of **movement operations**, where elements move from one position in the phrase structure to another.

Generating PF and LF structures

The sequence of movement operations is divided into two subsequences.

- First there's a sequence of **overt movement operations**
- Then there's a sequence of **covert movement operations**.

The PF of a sentence is **read off** the phrase structure after the overt movement operations. The LF is created by executing the remaining covert movement operations.

An example sentence: *The man grabbed a cup*

Phrase formation operations create the following XP structure:

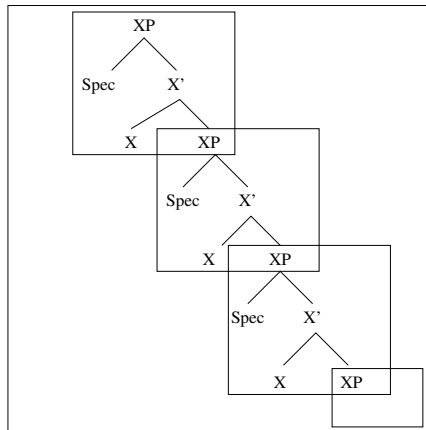

An example sentence: *The man grabbed a cup*

Each XP is of a different type:

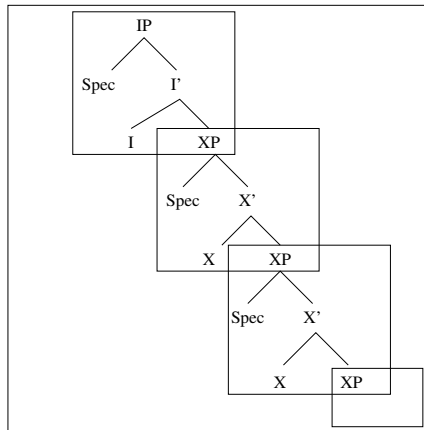

An example sentence: *The man grabbed a cup*

Each XP is of a different type:

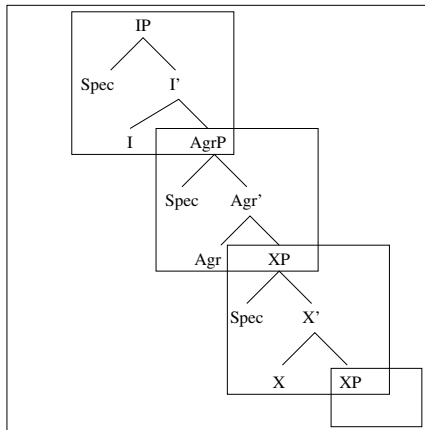

An example sentence: *The man grabbed a cup*

Each XP is of a different type:

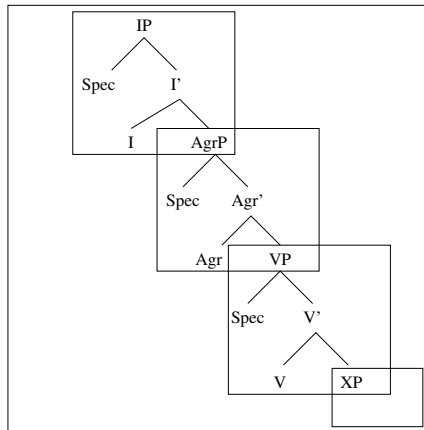

An example sentence: *The man grabbed a cup*

Each XP is of a different type:

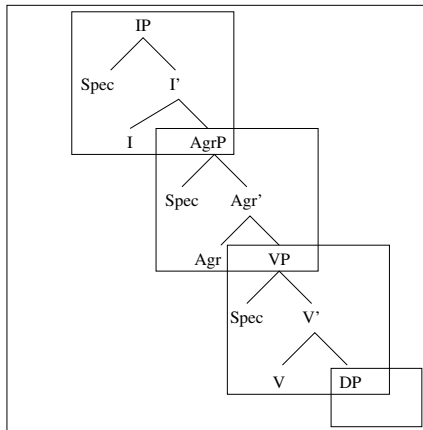

An example sentence: *The man grabbed a cup*

VP is headed by a verb, and introduces two **DPs**:

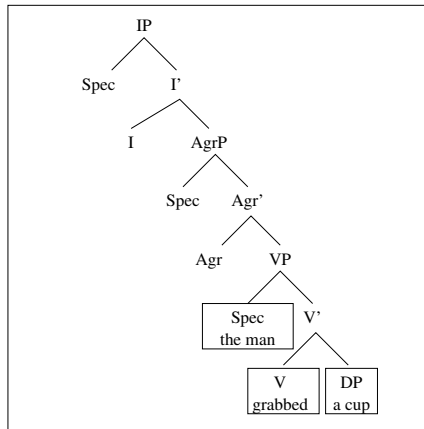

An example sentence: *The man grabbed a cup*

Movement operations are of two types. One is **DP movement**:

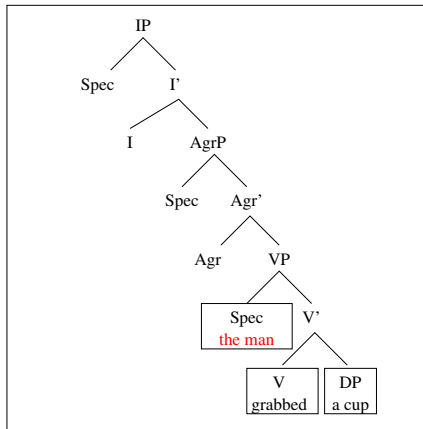

An example sentence: *The man grabbed a cup*

Movement operations are of two types. One is **DP movement**:

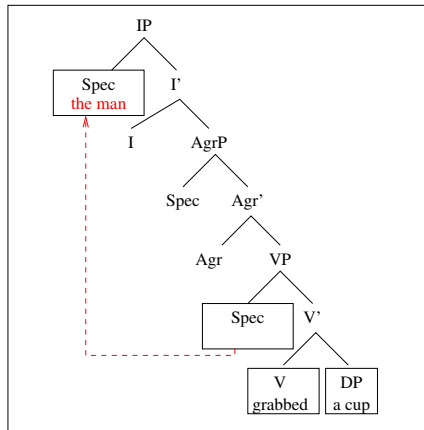

An example sentence: *The man grabbed a cup*

Movement operations are of two types. One is **DP movement**:

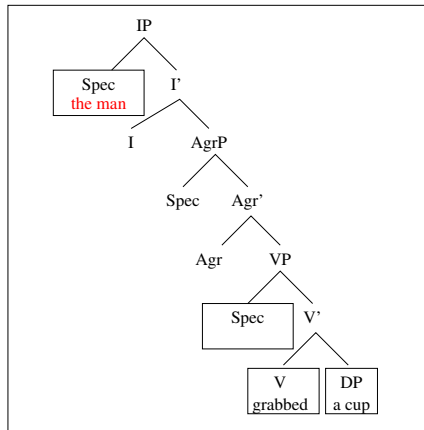

An example sentence: *The man grabbed a cup*

Movement operations are of two types. One is **DP movement**:

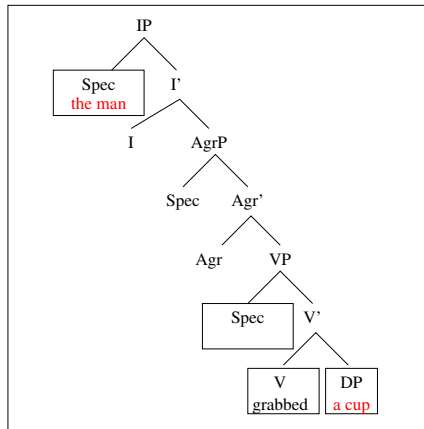

An example sentence: *The man grabbed a cup*

Movement operations are of two types. One is **DP movement**:

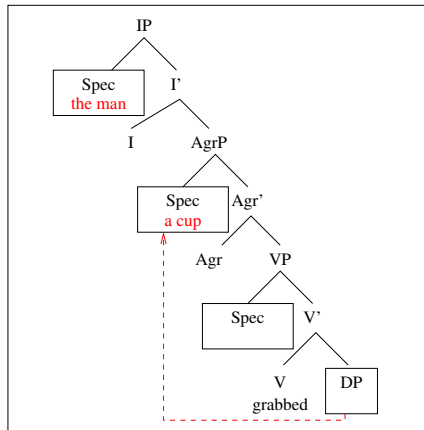

An example sentence: *The man grabbed a cup*

Movement operations are of two types. One is **DP movement**:

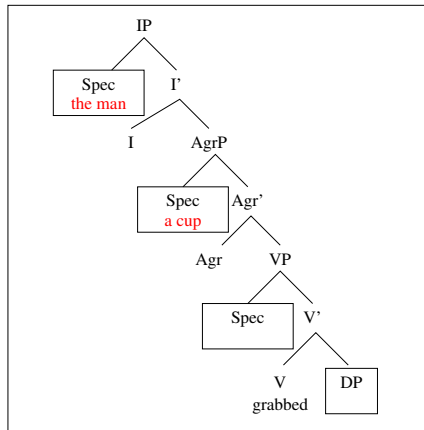

An example sentence: *The man grabbed a cup*

The other type of movement is **head movement**:

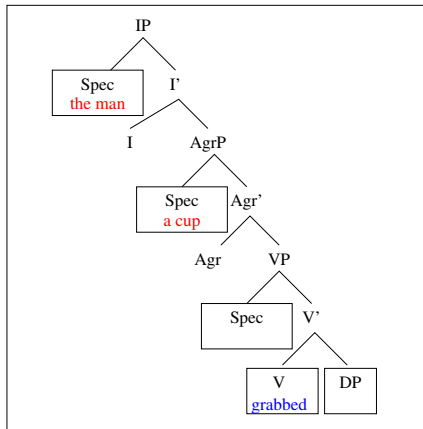

An example sentence: *The man grabbed a cup*

The other type of movement is **head movement**:

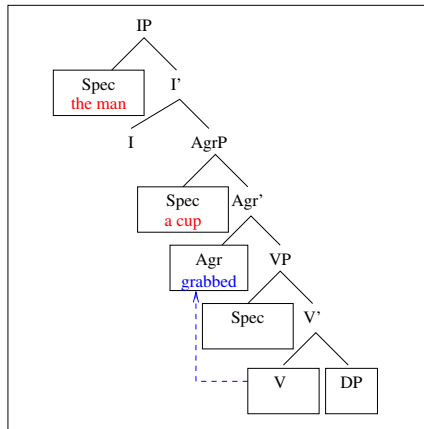

An example sentence: *The man grabbed a cup*

The other type of movement is **head movement**:

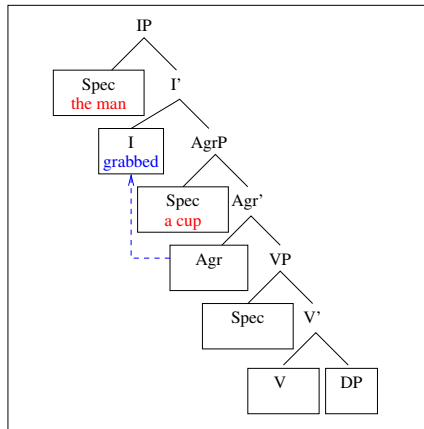

An example sentence: *The man grabbed a cup*

The other type of movement is **head movement**:

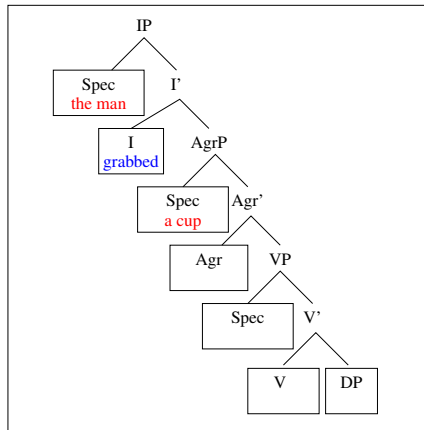

An example sentence: *The man grabbed a cup*

Moved elements remain linked to their previous position(s):

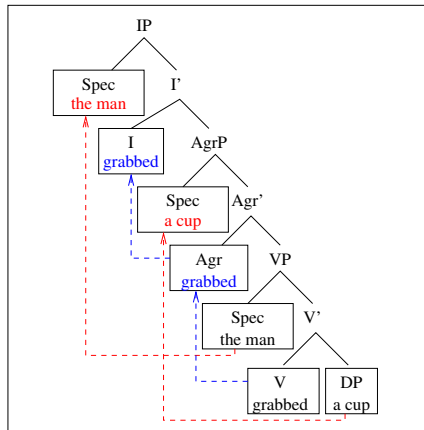

An example sentence: *The man grabbed a cup*

Some movement operations are **overt**, and some are **covert**:

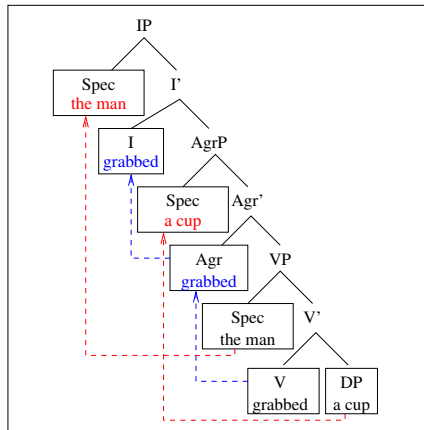

An example sentence: *The man grabbed a cup*

Languages have different patterns of overt/covert movement:

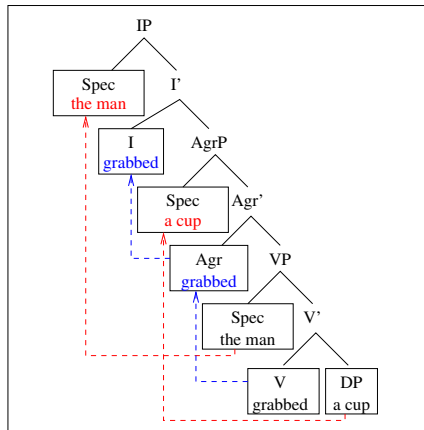

An example sentence: *The man grabbed a cup*

English PF looks like this:

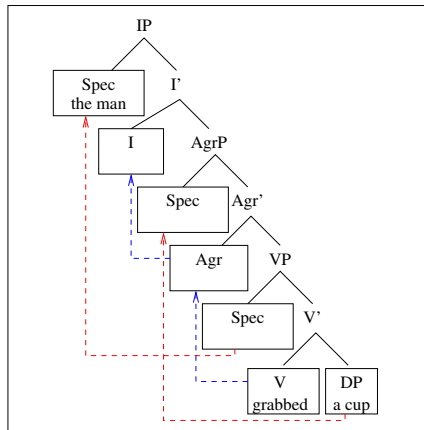

An example sentence: *The man grabbed a cup*

French/Italian PF looks like this:

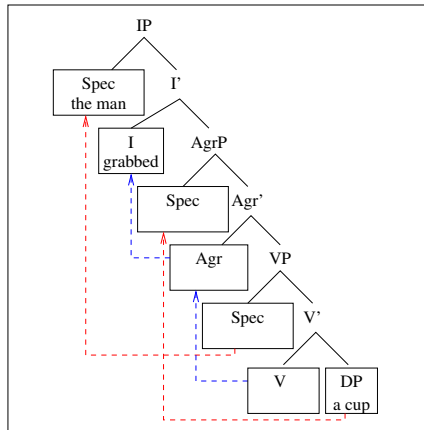

An example sentence: *The man grabbed a cup*

Māori PF looks like this:

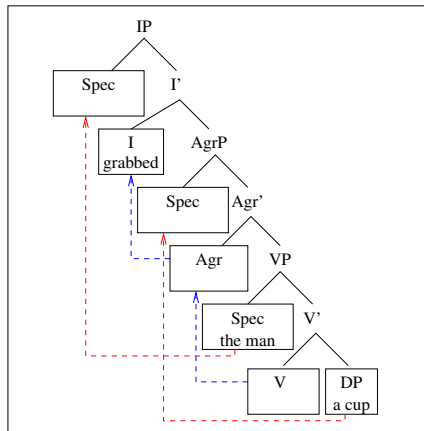

An example sentence: *The man grabbed a cup*

(Perhaps) Japanese PF looks like this:

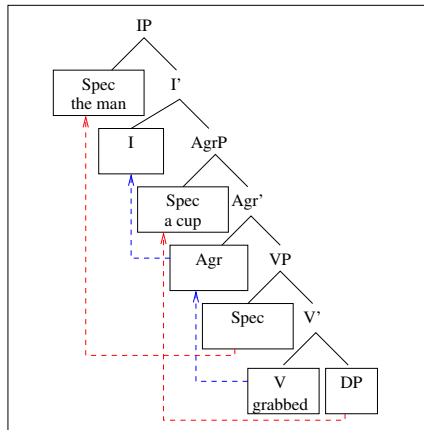

Outline of today's lecture

- 1 What do linguists do?
- 2 Introduction to GB/Minimalism
- 3 Components of the Minimalist model
- 4 Minimalist analysis of a transitive clause**

Motivating the structure of *The man grabbed a cup*

The X-bar structure of a transitive sentence is motivated from a complex body of arguments.

I'll introduce the structure incrementally.

An asymmetry between subject and object

Recall the simple structure we gave to begin with:

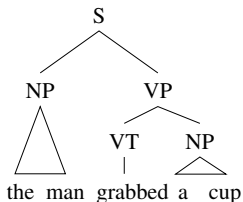

Note that the verb binds more tightly to its object than to its subject. Here are some motivations for this:

- John grabbed a cup. Bill **did so** too.
- All sentences have subjects.
Whether a sentence has an object depends on the verb.

The IP projection

Verbs can have **inflections**: e.g. *grabs*, *grabbed*.

When a sentence features an **auxiliary verb**, the main verb is always uninflected (**nonfinite**).

- John can walk.
- *John can walks.

This suggests that the auxiliary verb in some sense takes the place of an inflection.

The IP projection

The GB idea: auxiliary verbs have their own XP, which sits above VP.

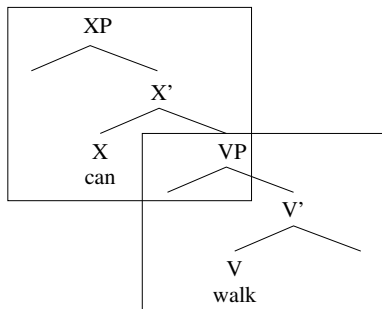

The IP projection

The GB idea: auxiliary verbs have their own XP, which sits above VP.

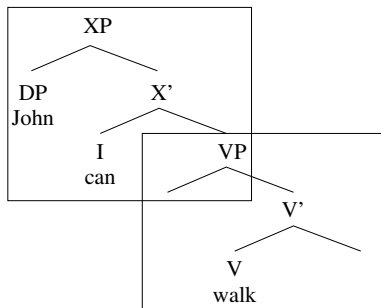

- The subject of the verb appears at the Spec of this XP.

The IP projection

The GB idea: auxiliary verbs have their own XP, which sits above VP.

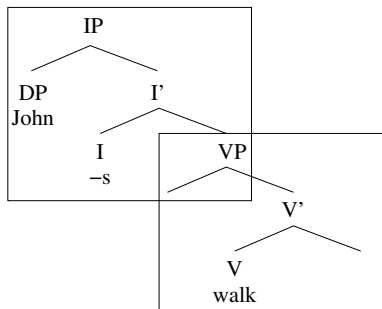

- The subject of the verb appears at the Spec of this XP.
- Verb inflections originate as heads of this same XP.
For this reason, it's called **IP** ('inflection phrase').

The IP projection

The GB idea: auxiliary verbs have their own XP, which sits above VP.

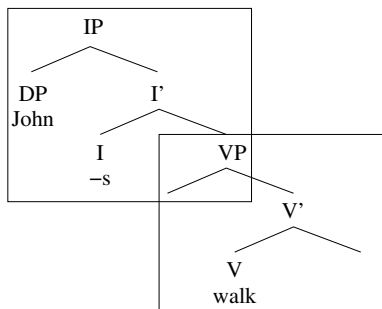

- The subject of the verb appears at the Spec of this XP.
- Verb inflections originate as heads of this same XP. For this reason, it's called **IP** ('inflection phrase').
- Note that inflections *agree with the subject*.

Movement between V and I

The GB idea: auxiliary verbs have their own XP, which sits above VP.

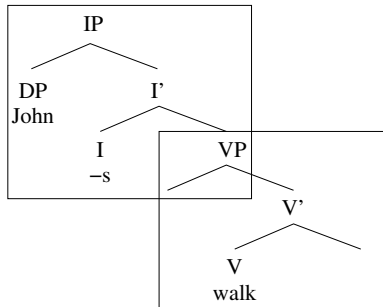

- The inflection (I) and verb (V) have to come together at PF.
- The GB analysis: V raises to I in some languages (e.g. French), and I lowers to V in other languages (e.g. English).
- This gives a nice explanation of some differences in word order.

Movement between V and I

John often drinks tea

Jean boit souvent du thé

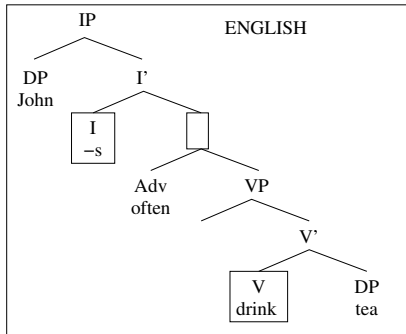

Movement between V and I

John often drinks tea

Jean boit souvent du thé

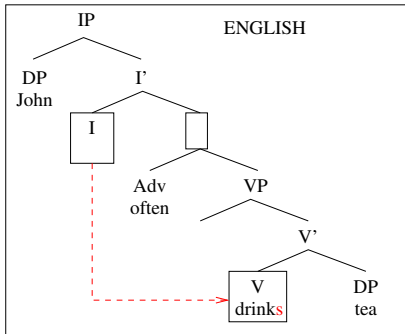

Movement between V and I

John often drinks tea

Jean boit souvent du thé

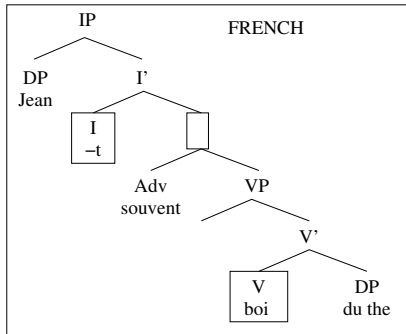

Movement between V and I

John often drinks tea

Jean boit souvent du thé

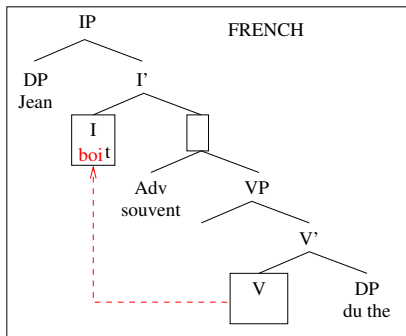

Movement between V and I

John does not drink tea

Jean (ne) boit pas du thé

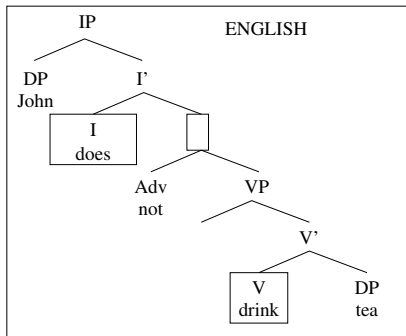

Movement between V and I

John does not drink tea
 Jean (ne) boit pas du thé

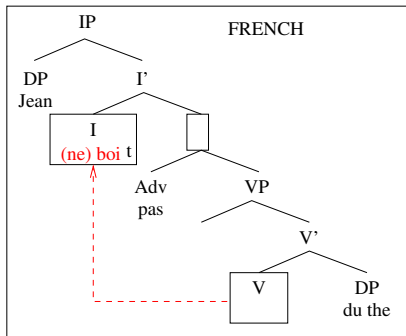

Evidence from question formation

The GB story:

- Questions have an extra projection above IP, called **CP**.
- Questions require I to move to the head of CP.

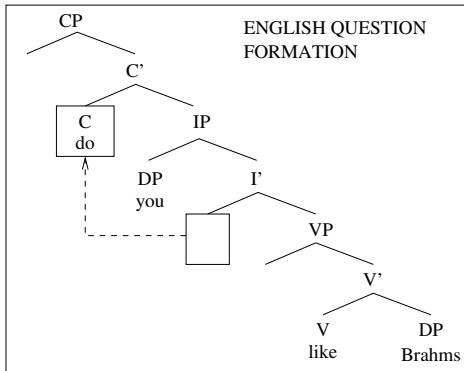

Evidence from question formation

The GB story:

- Questions have an extra projection above IP, called **CP**.
- Questions require I to move to the head of CP.

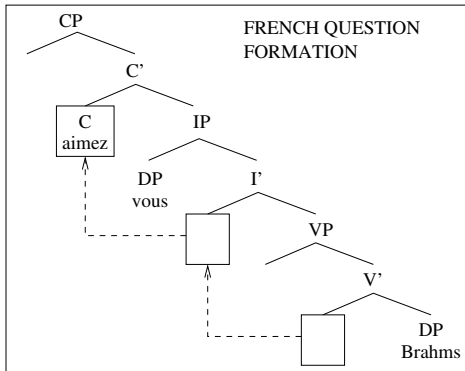

Summary

- Clause structure has a **CP**, an **IP** and an **VP**.
- Heads can (iteratively) raise or lower to adjacent heads.
- Subject-verb agreement is implemented at the inflectional head.

A Minimalist revision

In Minimalism, all movement is upwards (i.e. to the left).

- Phrase-formation operations generate a *fully inflected verb* at V.
- This verb always raises to I (and to C if there is one).
- In French, this movement is *overt*; in English, it's *covert*.

DP movement and Case assignment

In generative grammar, DPs undergo movement as well as heads.

To introduce the idea, consider these two sentences:

- (1) It seems John walks.
- (2) John seems to walk.

How can we explain that the sentences have the same meaning?

- *John* is clearly the AGENT of *walks* in both (1) and (2).
- But in (2), *John* is the subject of *seems*.

The GB proposal: (1) and (2) derive from the same LF structure.

DP movement and Case assignment

The GB proposal: *seem* takes a whole clause as its complement.

- *John* is the subject of this complement clause at LF.
- A verb 'assigns' AGENT/PATIENT to positions *in its local clause*.
- [Spec,IP] is the AGENT; [Comp,V] is the PATIENT.

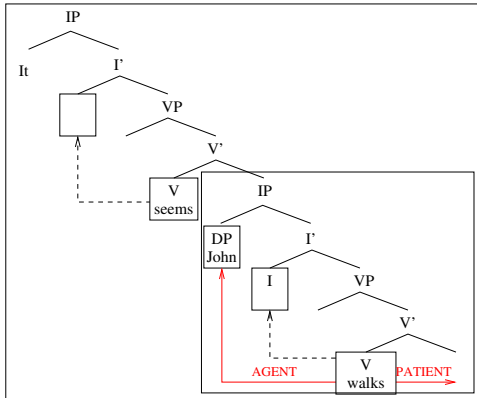

DP movement and Case assignment

The GB proposal: *seem* takes a whole clause as its complement.

- *John* is the subject of this complement clause at LF.
- A verb 'assigns' AGENT/PATIENT to positions *in its local clause*.
- [Spec,IP] is the AGENT; [Comp,V] is the PATIENT.

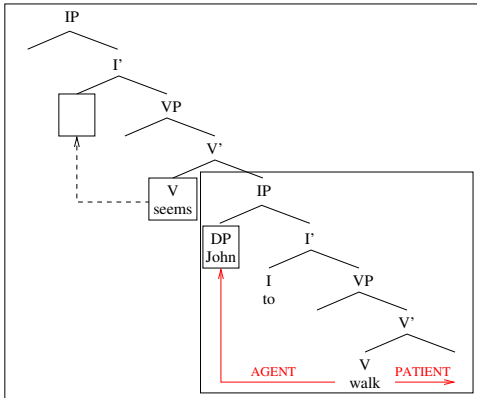

DP movement and Case assignment

The GB proposal: *seem* takes a whole clause as its complement.

- *John* is the subject of this complement clause at LF.
- The verb *seem* doesn't have a subject of its own at LF.
- This allows *John* to **raise** into the empty subject position at PF.

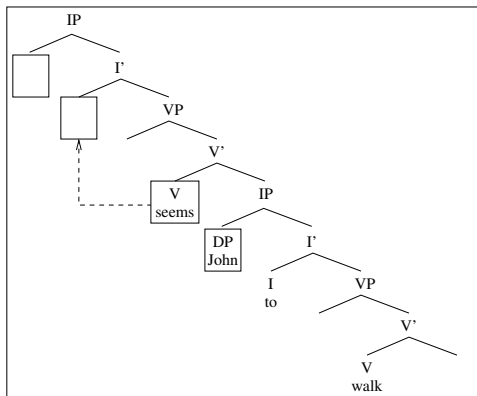

DP movement and Case assignment

The GB proposal: *seem* takes a whole clause as its complement.

- *John* is the subject of this complement clause at LF.
- The verb *seem* doesn't have a subject of its own at LF.
- This allows *John* to **raise** into the empty subject position at PF.

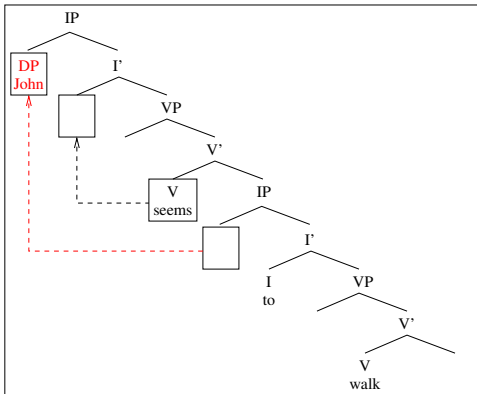

DP movement and Case assignment

Note that movement is *obligatory* if the complement verb is nonfinite.

(3) *It seems John to walk.

The GB explanation relates to a concept called **Case**.

- Every DP must be 'assigned' Case.
- Object DPs get (acc) Case from the V which introduces them.
- Subject DPs get (nom) Case from the I which introduces them.

DP movement and Case assignment

Note that movement is *obligatory* if the complement verb is nonfinite.

(3) *It seems John to walk.

The GB explanation relates to a concept called **Case**.

- Every DP must be ‘assigned’ Case.
- Object DPs get (acc) Case from the V which introduces them.
- Subject DPs get (nom) Case from the I which introduces them.

GB proposes that **only finite I can assign Case**.

This means *John* must raise to the higher [Spec,IP] *to get Case*.

Summary

- A verb assigns **thematic roles** (e.g. AGENT, PATIENT) to its arguments *locally*, within its clause.
- The subject of a nonfinite clause has to raise to a higher IP to get Case.

The VP-internal subject hypothesis

In later versions of GB and in Minimalism, the idea of subject raising is extended to simple clauses like *John grabbed a cup*.

- The subject originates at [Spec,VP] and raises to [Spec,IP].

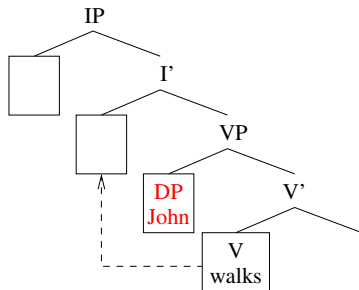

The VP-internal subject hypothesis

In later versions of GB and in Minimalism, the idea of subject raising is extended to simple clauses like *John grabbed a cup*.

- The subject originates at [Spec,VP] and raises to [Spec,IP].

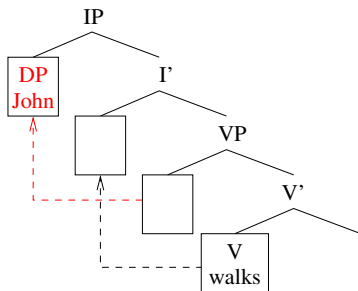

Motivating VP-internal subjects

1. **Auxiliary verbs** are a lot like raising verbs (e.g. *seem*).
 - Semantically, they introduce a whole proposition.
John can walk = 'It can be that [John walks]
 - They can have empty subjects. (E.g. *It can rain hard here.*)

This suggests a raising analysis.

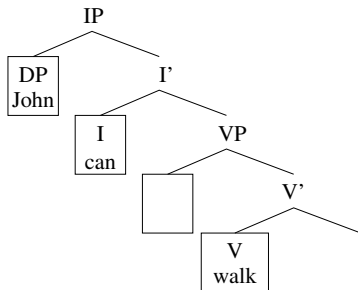

Motivating VP-internal subjects

1. **Auxiliary verbs** are a lot like raising verbs (e.g. *seem*).
 - Semantically, they introduce a whole proposition.
John can walk = 'It can be that [John walks]
 - They can have empty subjects. (E.g. *It can rain hard here.*)

This suggests a raising analysis.

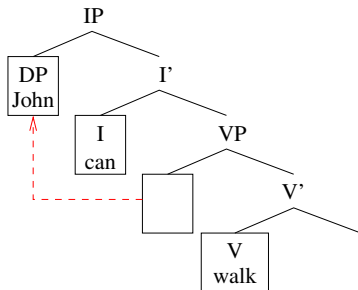

Motivating VP-internal subjects

2. If subjects originate within the VP, then we can tell a simple story about how thematic roles (e.g. AGENT, PATIENT) are assigned.

If subjects originate at [Spec,IP]:

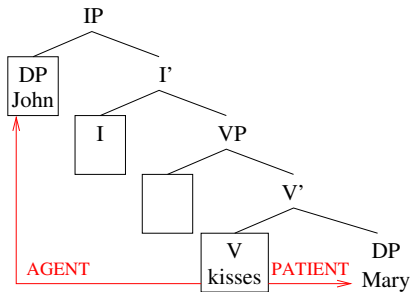

Motivating VP-internal subjects

2. If subjects originate within the VP, then we can tell a simple story about how thematic roles (e.g. AGENT, PATIENT) are assigned.

If subjects originate at [Spec,VP]:

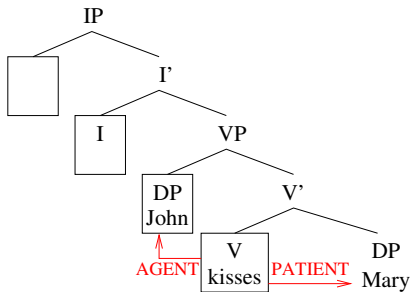

Motivating VP-internal subjects

2. If subjects originate within the VP, then we can tell a simple story about how thematic roles (e.g. AGENT, PATIENT) are assigned.

If subjects originate at [Spec,VP]:

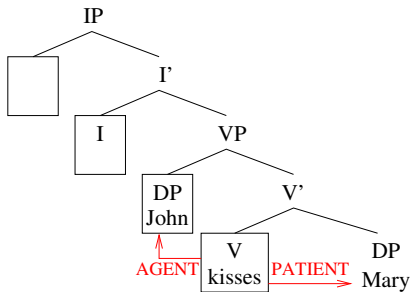

So: subjects get thematic role at [Spec,VP], and Case at [Spec,IP].

Motivating VP-internal subjects

3. VSO languages become easy to explain.

If subjects originate at [Spec,VP], then we can generate VSO order by:

- making subject raising *covert*;
- making verb raising *overt*.

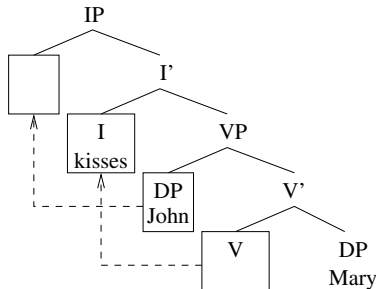

The AgrP projection

In late GB and in Minimalism, objects also raise out of the VP, to the Spec of a new projection called **Agr_OP** (I'll say **AgrP** for short).

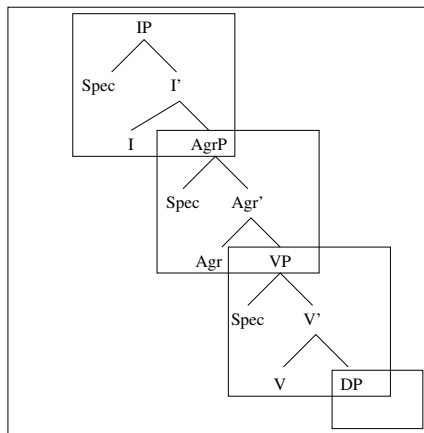

The AgrP projection

In late GB and in Minimalism, objects also raise out of the VP, to the Spec of a new projection called **Agr_OP** (I'll say **AgrP** for short).

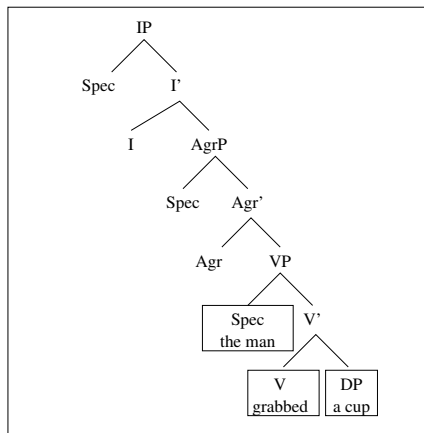

The AgrP projection

In late GB and in Minimalism, objects also raise out of the VP, to the Spec of a new projection called **Agr_OP** (I'll say **AgrP** for short).

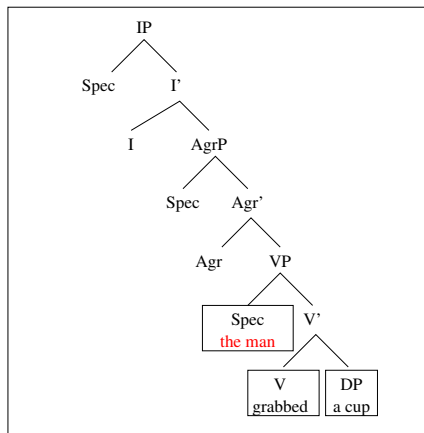

The AgrP projection

In late GB and in Minimalism, objects also raise out of the VP, to the Spec of a new projection called **Agr_OP** (I'll say **AgrP** for short).

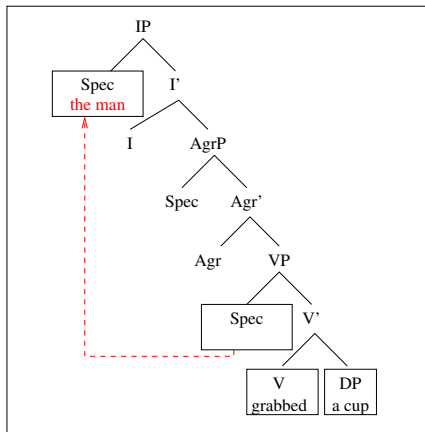

The AgrP projection

In late GB and in Minimalism, objects also raise out of the VP, to the Spec of a new projection called **Agr_OP** (I'll say **AgrP** for short).

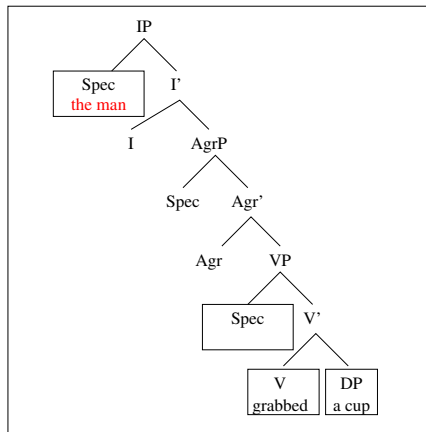

The AgrP projection

In late GB and in Minimalism, objects also raise out of the VP, to the Spec of a new projection called **Agr_OP** (I'll say **AgrP** for short).

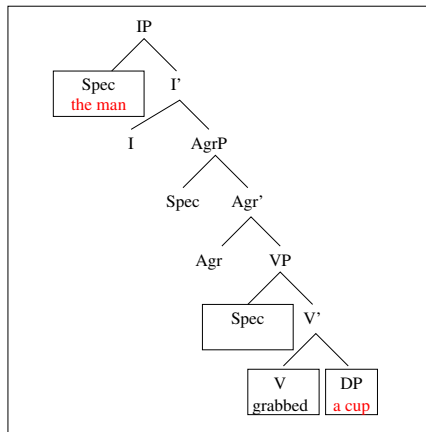

The AgrP projection

In late GB and in Minimalism, objects also raise out of the VP, to the Spec of a new projection called **Agr_OP** (I'll say **AgrP** for short).

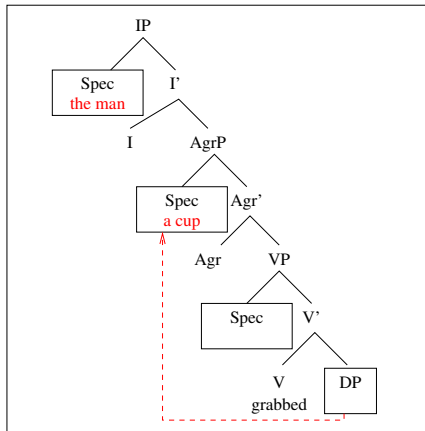

The AgrP projection

In late GB and in Minimalism, objects also raise out of the VP, to the Spec of a new projection called **Agr_OP** (I'll say **AgrP** for short).

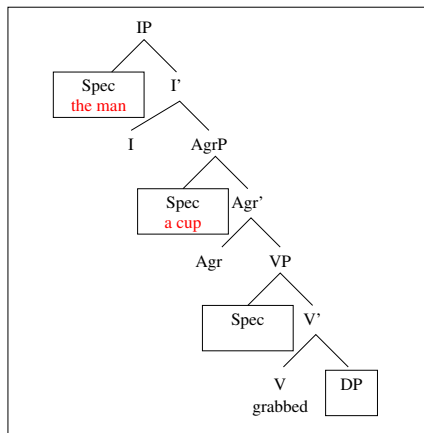

The AgrP projection

In late GB and in Minimalism, objects also raise out of the VP, to the Spec of a new projection called **Agr_OP** (I'll say **AgrP** for short).

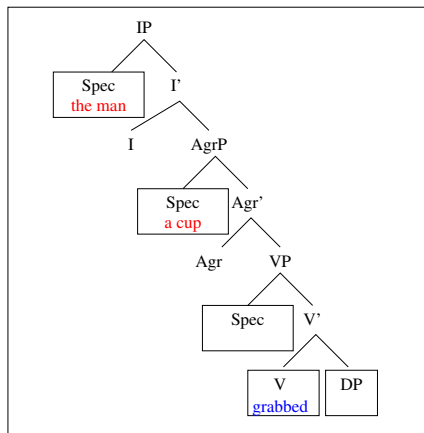

The AgrP projection

In late GB and in Minimalism, objects also raise out of the VP, to the Spec of a new projection called **Agr_OP** (I'll say **AgrP** for short).

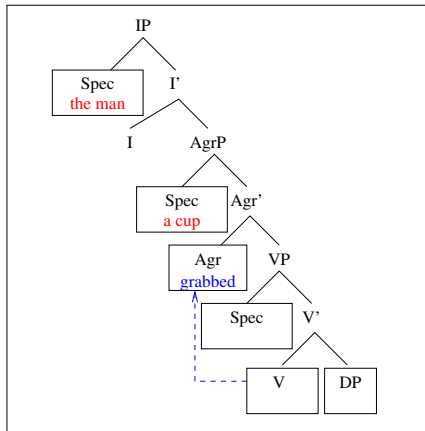

The AgrP projection

In late GB and in Minimalism, objects also raise out of the VP, to the Spec of a new projection called **Agr_OP** (I'll say **AgrP** for short).

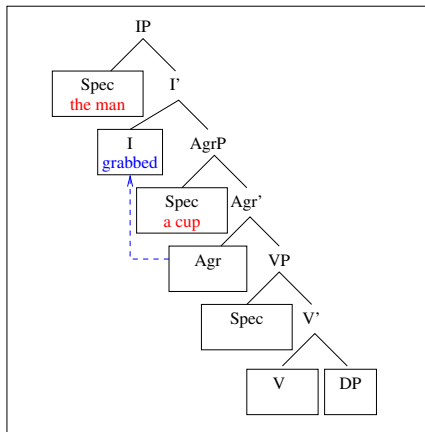

The AgrP projection

In late GB and in Minimalism, objects also raise out of the VP, to the Spec of a new projection called **Agr_OP** (I'll say **AgrP** for short).

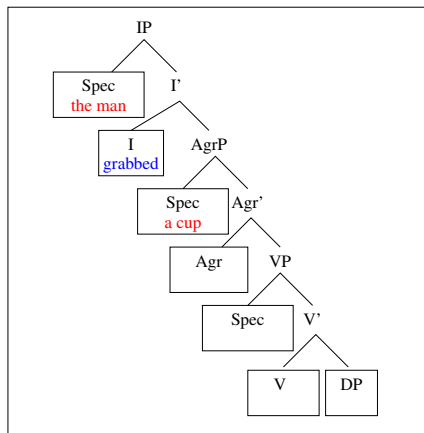

Motivating AgrP

Some languages allow the object of a transitive verb to appear before the verb.

This happens in Irish nonfinite clauses:

Ba mhaith liom	John	an	abairt	a	scríobh
I want	John	the	sentence(ACC)	write	
'I want John to write the sentence'					

One possible explanation:

- There's a position in between IP and VP which the object can move to.

Motivating AgrP

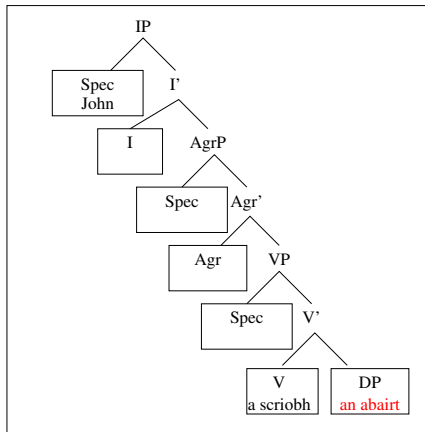

The object starts off in the complement position.

Motivating AgrP

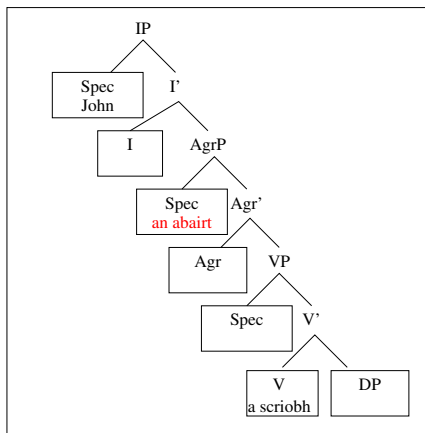

The object starts off in the complement position.
Then it moves to the specifier of the intermediate position.

Motivating AgrP

Pollock (1989): there's a projection in between IP and VP.

In finite clauses:

English *have* and *be* can raise past both adverbs and negation, while lexical verbs cannot.

- (1) John **is** often happy / John **is** not happy
- (2) *John **drinks** often tea / *John **drinks** not tea

French lexical verbs *AND have / be* can raise past both adverbs and negation.

- (3) Jean **est** souvent heureux / Jean **n'est** pas heureux
- (4) Jean **boit** souvent du thé / Jean **ne boit** pas du thé

Motivating AgrP

Pollock (1989): there's a projection in between IP and VP.

In nonfinite clauses:

English *have/be* can raise past both adverbs and negation, while lexical verbs cannot.

(5) **To be** often happy / **To be** not happy

(6) ***To kiss** often Mary / ***To kiss** not Mary

French *have* and *be* can raise past both adverbs and negation, while lexical verbs can only raise past adverbs.

(7) **Être** souvent heureux / **N'être** pas heureux

(8) **Embrasser** souvent Marie / * **N'embrasser** pas Marie

Motivating AgrP

Some generalisations:

1. If a verb can move past negation, it can always move past adverbs. (But the reverse is not true.)
2. French lexical verbs can move past adverbs. But English lexical verbs can't.
3. In French and English, *be/have* can always move past negation.

Motivating AgrP

Pollock: we can explain these generalisations neatly by assuming that verbs raise from V to I *in two hops*:

- First they raise beyond the adverb position to an intermediate head.
- Then they raise beyond negation to the I head.

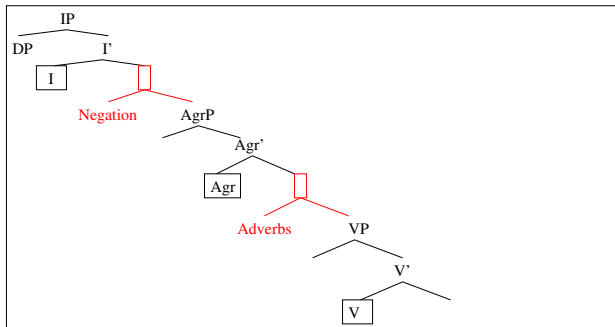

Motivating AgrP

Pollock: we can explain these generalisations neatly by assuming that verbs raise from V to I *in two hops*:

- First they raise beyond the adverb position to an intermediate head.
- Then they raise beyond negation to the I head.

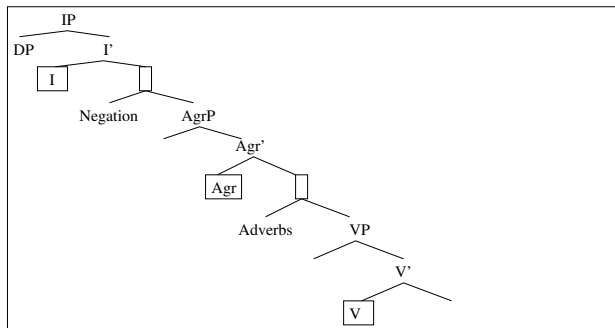

Motivating AgrP

Pollock: we can explain these generalisations neatly by assuming that verbs raise from V to I *in two hops*:

- First they raise beyond the adverb position to an intermediate head.
- Then they raise beyond negation to the I head.

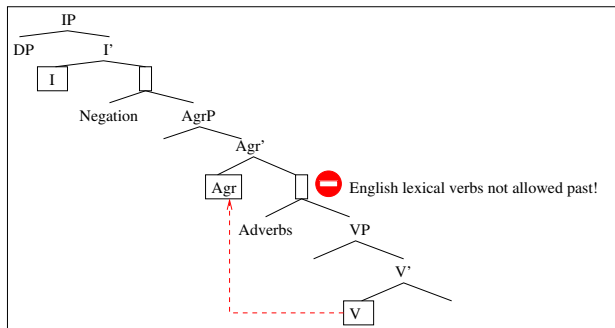

Motivating AgrP

Pollock: we can explain these generalisations neatly by assuming that verbs raise from V to I *in two hops*:

- First they raise beyond the adverb position to an intermediate head.
- Then they raise beyond negation to the I head.

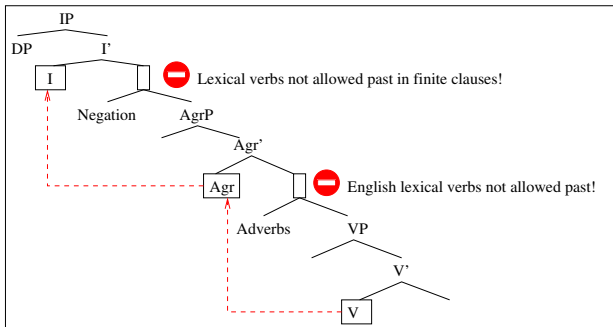

Motivating AgrP

Pollock: Agr and I contribute different elements of verb morphology.

- Agr contributes **agreement** morphology
- I contributes **tense** morphology. (He renamed I T.)

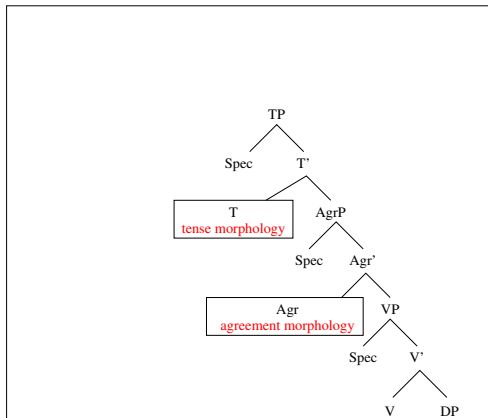

Motivating AgrP

Belletti: the agreement head must be above the tense head.

- Tense morphemes attach before agreement morphemes.
- E.g. *parl-av-ano...*

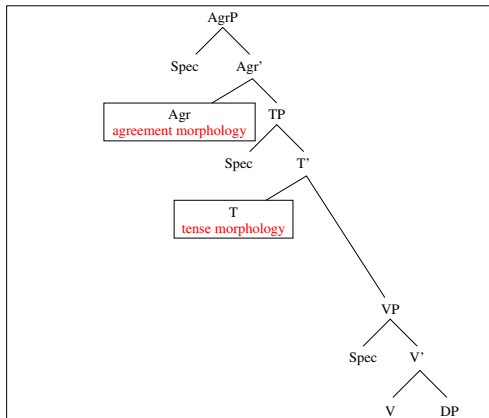

Motivating AgrP

Chomsky (1995): there are two Agr projections.

- The one above T carries *subject agreement* morphology.
- The one below T carries *object agreement* morphology.

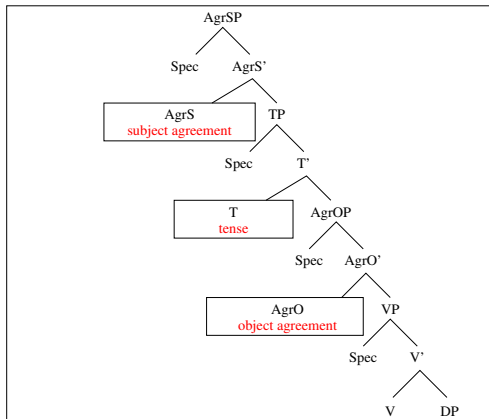

Motivating AgrP

Chomsky (1995): there are two Agr projections.

- The one above T assigns *nominative Case* to its Specifier.
- The one below T assigns *accusative Case* to its Specifier.

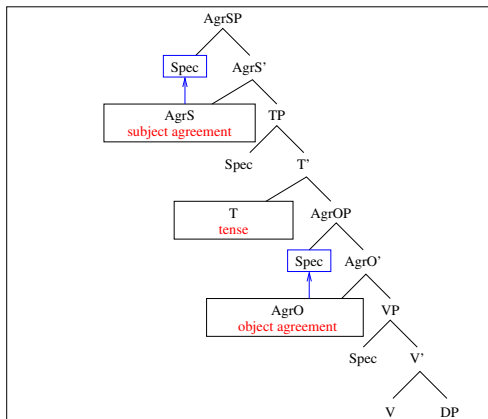

Motivating AgrP

Ali (2009):

- To keep things simple, I'll collapse subject agreement and T.
- I'll call the combination IP.

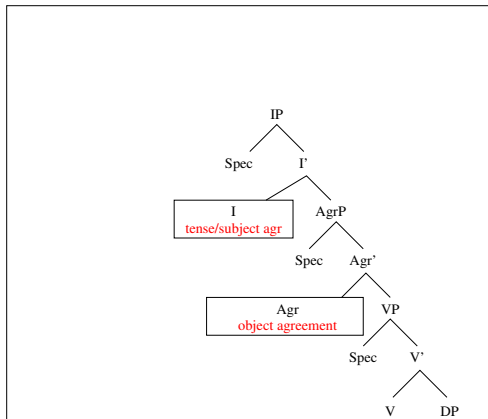

Motivating Agr

Why should the intermediate projection relate to object agreement?

1. It creates a uniform Case assignment mechanism.

- Both nom. and acc. Case are assigned by a functional head to its Specifier.
- DPs raise out of the VP to get Case.

Motivating Agr

Why should the intermediate projection relate to object agreement?

1. It creates a uniform Case assignment mechanism.
 - Both nom. and acc. Case are assigned by a functional head to its Specifier.
 - DPs raise out of the VP to get Case.
2. It provides a simple way of explaining SOV order.
 - S raises to [Spec,IP] (at PF)
 - O raises to [Spec,AgrP] (at PF)
 - V stays in the VP (at PF).

Summary

The verb and its arguments originate in the VP.

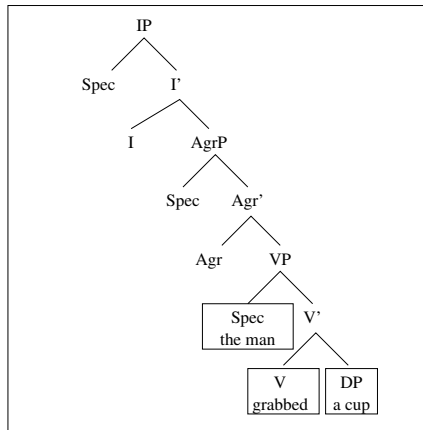

Summary

The subject raises to [Spec,IP] to get Case.

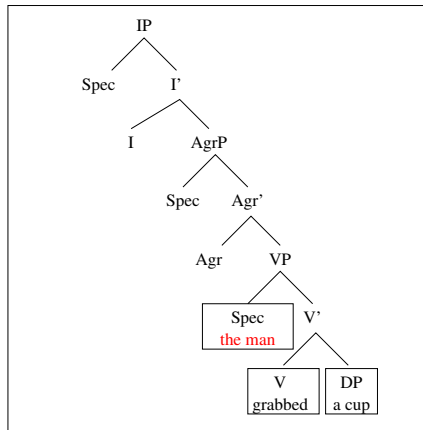

Summary

The subject raises to [Spec,IP] to get Case.

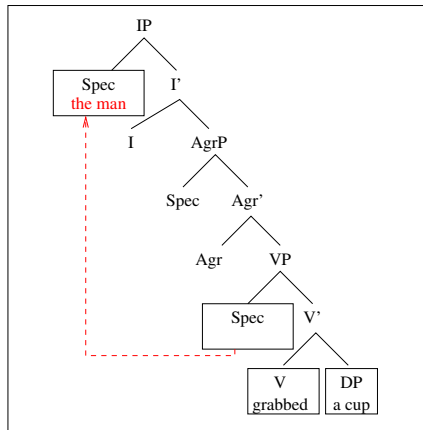

Summary

The subject raises to [Spec,IP] to get Case.

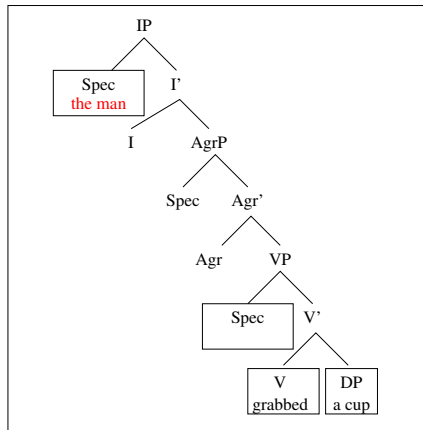

Summary

The object raises to [Spec,AgrP] to get Case.

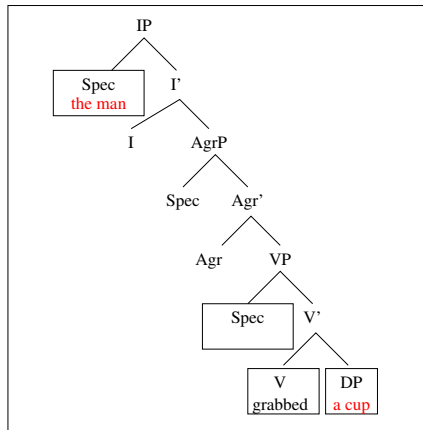

Summary

The object raises to [Spec,AgrP] to get Case.

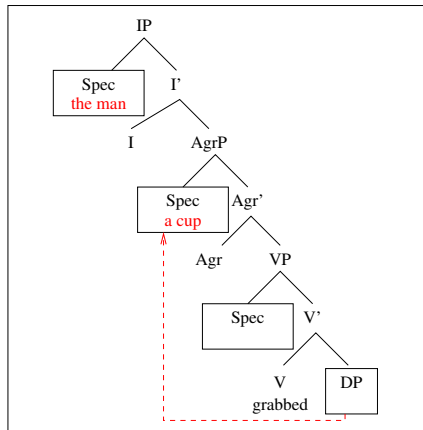

Summary

The object raises to [Spec,AgrP] to get Case.

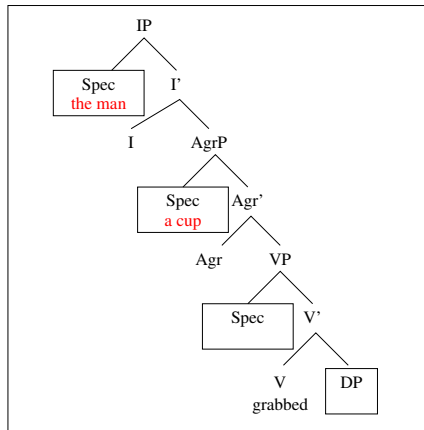

Summary

The verb raises successively to the Agr and I heads.

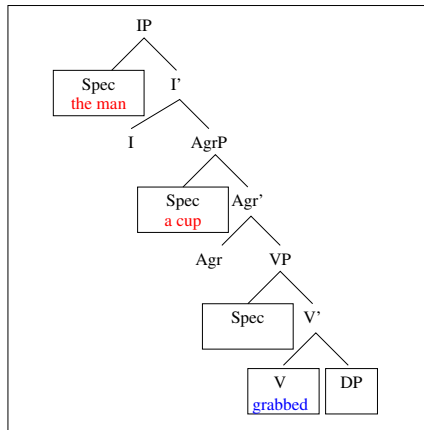

Summary

The verb raises successively to the Agr and I heads.

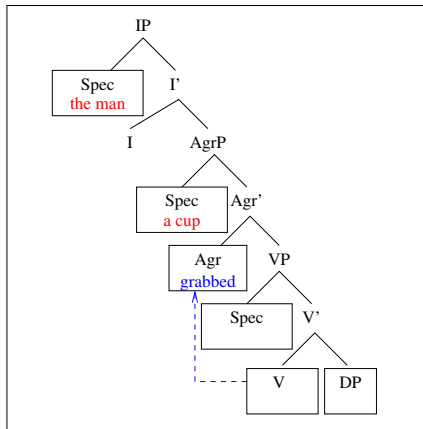

Summary

The verb raises successively to the Agr and I heads.

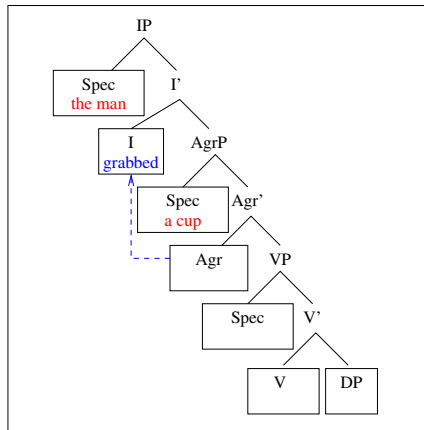

Summary

The verb raises successively to the Agr and I heads.

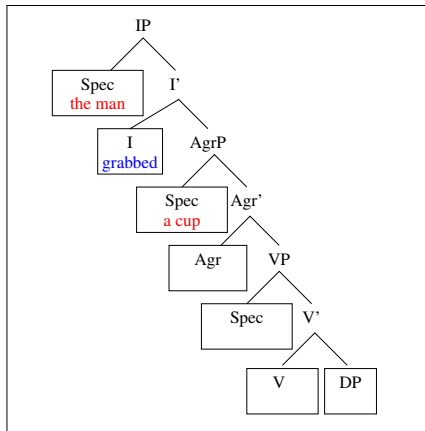

Summary

Moved elements leave traces.

